

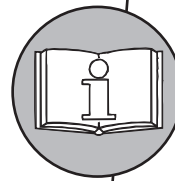

Idling pressure in cabin

- COP 4050 CR - 50 bar
- COP 1838 CR - 25 bar
- COP 1850 CR - 25 bar
- COP 2150 CR - 25 bar
- COP 2550 CR - 25 bar

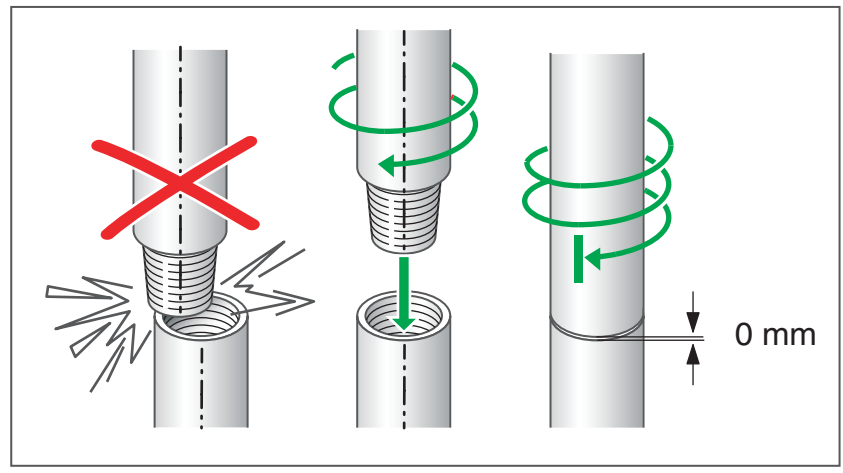
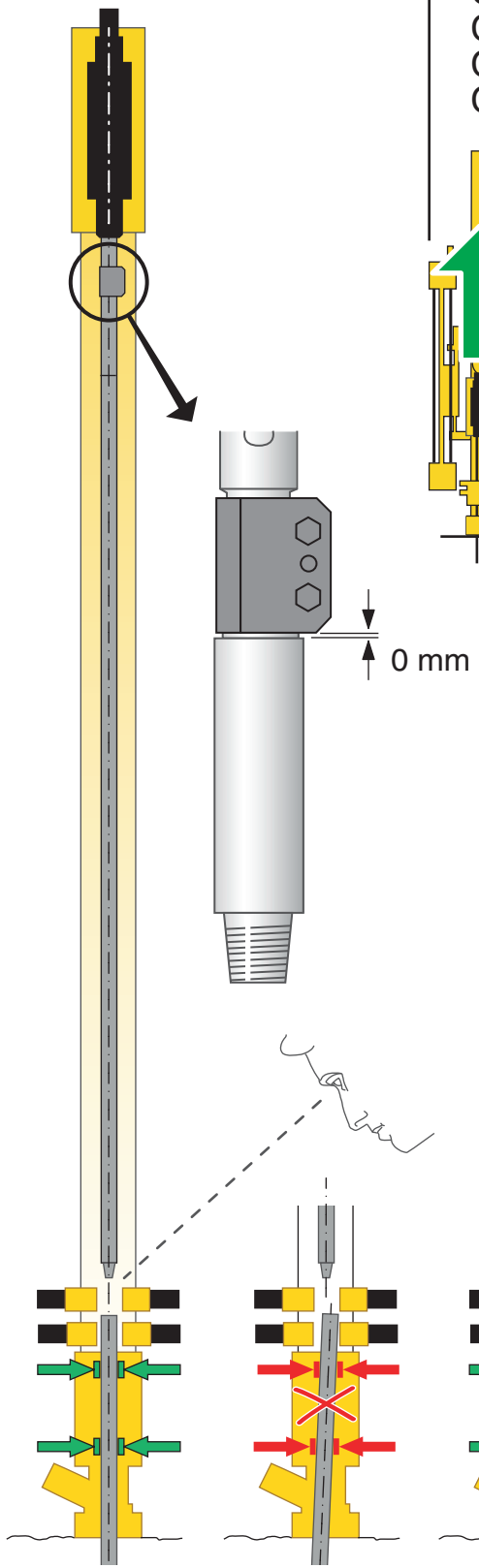
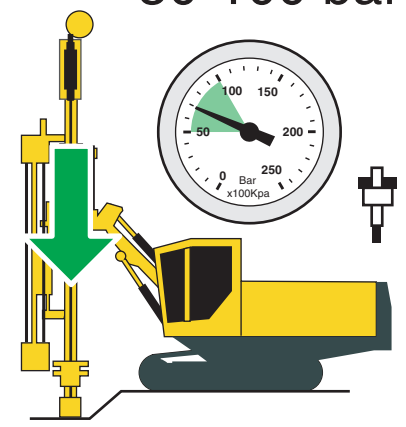
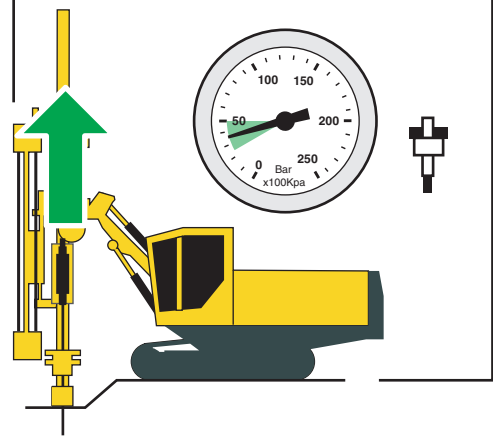

50-100 bar

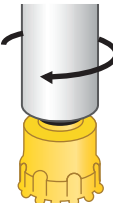

	90mm = 95-115 °C
	95mm = 90-110 °C
	105mm = 80-100 °C
	110mm = 75-95 °C
	115mm = 70-90 °C
	127mm = 60-80 °C
	140mm = 70-90 °C
	152mm = 65-85 °C
	165mm = 60-80 °C

1 min.

